

ANNEX I
SUMMARY OF PRODUCT CHARACTERISTICS

1. NAME OF THE MEDICINAL PRODUCT

Ruconest 2100 Units powder for solution for injection.

2. QUALITATIVE AND QUANTITATIVE COMPOSITION

One vial contains 2100 units of conestat alfa, corresponding to 2100 units per 14 ml after reconstitution, or a concentration of 150 units/ml.

Conestat alfa is a recombinant analogue of the human C1 esterase inhibitor (rhC1-INH) produced by recombinant DNA technology in the milk of transgenic rabbits.

1 unit of conestat alfa activity is defined as the equivalent of C1 esterase inhibiting activity present in 1 ml of pooled normal plasma.

Excipient with known effect:

Each vial contains approximately 19.5 mg sodium.

For the full list of excipients, see section 6.1.

3. PHARMACEUTICAL FORM

Powder for solution for injection.

White to off-white powder.

4. CLINICAL PARTICULARS

4.1 Therapeutic indications

Ruconest is indicated for treatment of acute angioedema attacks in adults, adolescents, and children (aged 2 years and above) with hereditary angioedema (HAE) due to C1 esterase inhibitor deficiency.

4.2 Posology and method of administration

Ruconest should be initiated under the guidance and supervision of a physician experienced in the diagnosis and treatment of hereditary angioedema.

Posology in adults, adolescents and children aged 2 years and above

Body weight up to 84 kg

- One intravenous injection of 50 U/kg body weight.

Body weight of 84 kg or greater

- One intravenous injection of 4200 U (2 vials).

In the majority of cases, a single dose of Ruconest is sufficient to treat an acute angioedema attack.

In case of an insufficient clinical response, an additional dose (50 U/kg body weight up to 4200 U) can be administered at the discretion of the physician (see section 5.1).

- In adults and adolescents an additional dose may be administered if the patient has not responded adequately after 120 minutes.
- In children an additional dose may be administered if the patient has not responded adequately after 60 minutes.

Not more than two doses should be administered within 24 hours.

Dose calculation

Determine the patient's body weight.

Body weight up to 84 kg

- For patients up to 84 kg calculate the volume required to be administered according to the formula below:

$$\text{Volume to be administered (ml)} = \frac{\text{body weight (kg) times 50 (U/kg)}}{150 \text{ (U/ml)}} = \frac{\text{body weight (kg)}}{3}$$

Body weight of 84 kg or greater

- For patients of 84 kg or above the volume required to be administered is 28 ml, corresponding to 4200 U (2 vials).

Paediatric population

Ruconest may be used in paediatric patients (2 years and older) at the same dose as in adults (50 U/kg body weight).

The safety and efficacy of Ruconest in children less than 2 years old have not been established. No clinical data are available.

Elderly (≥65 years old)

Data in patients older than 65 years are limited.

There is no rationale for patients older than 65 years to respond differently to Ruconest.

Renal impairment

No dose adjustment is necessary in patients with renal impairment since conestat alfa does not undergo renal clearance.

Hepatic impairment

There is no clinical experience with Ruconest in patients with hepatic impairment. Hepatic impairment may prolong the plasma half-life of conestat alfa, but this is not thought to be a clinical concern. No recommendation on a dose adjustment can be made.

Method of administration

For intravenous use.

Ruconest should be administered by a healthcare professional.

For instructions on reconstitution of Ruconest before administration, see section 6.6.

The required volume of the reconstituted solution should be administered as a slow intravenous injection over approximately 5 minutes.

4.3 Contraindications

- Known or suspected allergy to rabbits (see section 4.4)
- Hypersensitivity to the active substance or to any of the excipients listed in section 6.1

4.4 Special warnings and precautions for use

Traceability

In order to improve the traceability of biological medicinal products, the name and the batch number of the administered products should be clearly recorded.

Conestat alfa is derived from milk of transgenic rabbits and contains traces of rabbit protein. Before initiating treatment with Ruconest, patients should be queried about prior exposure to rabbits and signs and symptoms suggestive of an allergic reaction.

Hypersensitivity reactions cannot be excluded and may have symptoms similar to angioedema attacks. All patients must be closely monitored and carefully observed for any symptoms of hypersensitivity during and after the administration period. Patients should be informed of the early signs of hypersensitivity

reactions e.g., hives, generalised urticaria, tightness of the chest, wheezing, hypotension and anaphylaxis. If these symptoms occur after administration, they should alert their physician.

In case of anaphylactic reactions or shock, emergency medical treatment should be administered.

Although cross-reactivity between cow milk and rabbit milk is considered unlikely, the possibility of such a cross-reactivity in a patient who has evidence of clinical allergy to cow milk cannot be excluded and the patient should be observed for signs and symptoms of hypersensitivity following Ruconest administration.

Thromboembolic events

Serious arterial and venous thromboembolic (TE) events have been reported at the recommended dose of plasma derived C1 esterase inhibitor products in patients with known risk factors (e.g., indwelling catheters, prior history of thrombosis, underlying atherosclerosis, use of oral contraceptives or certain androgens, morbid obesity, immobility). Patients with known risk factors should be monitored closely.

Sodium

Each vial of Ruconest contains 19.5 mg of sodium. To be taken into consideration by patients on a controlled sodium diet.

4.5 Interaction with other medicinal products and other forms of interaction

No interaction studies have been performed.

Scientific literature indicates an interaction of tissue-type plasminogen activator (tPA) and C1-INH containing medicinal products. Ruconest should not be administered simultaneously with tPA.

4.6 Fertility, pregnancy and lactation

Pregnancy and breast-feeding

There is no experience with the use of Ruconest in pregnant and breast-feeding women.

In one animal study reproductive toxicity was observed (see section 5.3). Ruconest is not recommended for use during pregnancy or breast-feeding, unless the treating physician judges the benefits to outweigh the possible risks.

Fertility

There are no data on the effects of Ruconest on male or female fertility.

4.7 Effects on ability to drive and use machines

Based on the known pharmacology and adverse reaction profile of Ruconest, effects on the ability to drive and use machines are not expected. However, headache, vertigo and dizziness have been reported following the use of Ruconest, but may also occur as a result of an attack of HAE. Patients should be advised not to drive and use machines if they experience headache, vertigo or dizziness.

4.8 Undesirable effects

Summary of the safety profile

One case of hypersensitivity was observed in clinical trials with Ruconest. The most common adverse reaction observed after administration of Ruconest is nausea.

Tabulated lists of adverse reactions

Adverse reactions reported with Ruconest in the treatment of acute HAE attacks obtained from clinical trials and post-marketing surveillance are tabulated below. In clinical trials, the incidence of adverse reactions was similar for all dose groups and did not increase upon repeated administration.

The frequency of adverse reactions listed below is defined using the following convention:

Very common ($\geq 1/10$),

Common ($\geq 1/100$ to $< 1/10$),

Uncommon ($\geq 1/1,000$ to $< 1/100$),
 Rare ($\geq 1/10,000$ to $< 1/1,000$),
 Very rare ($< 1/10,000$),
 Not known (cannot be estimated from the available data).

System Organ Class	Adverse reaction	Frequency
Nervous system disorders	Headache	Uncommon
	Vertigo	Uncommon
	Hypoaesthesia	Uncommon
	Dizziness	Uncommon
Ear and labyrinth disorders	Auricular swelling	Uncommon
Respiratory, thoracic and mediastinal disorders	Throat irritation	Uncommon
Gastrointestinal disorders	Nausea	Common
	Diarrhoea	Uncommon
	Abdominal discomfort	Uncommon
	Oral paraesthesia	Uncommon
Skin and subcutaneous tissue disorders	Urticaria	Uncommon
Immune system disorders	Anaphylaxis*	Uncommon
	Hypersensitivity reactions*	Not known

*Further information is found in section 4.4

Paediatric population

In the clinical development program, 37 children and adolescents (aged 5 to 17 years) with HAE were treated for 124 acute angioedema attacks. Frequency, type and severity of adverse reactions in children and adolescents were similar to those in adults.

Reporting of suspected adverse reactions

Reporting suspected adverse reactions after authorisation of the medicinal product is important. It allows continued monitoring of the benefit/risk balance of the medicinal product. Healthcare professionals are asked to report any suspected adverse reactions via the national reporting system listed in [Appendix V](#).

4.9 Overdose

No clinical information on overdose is available.

5. PHARMACOLOGICAL PROPERTIES

5.1 Pharmacodynamic properties

Pharmacotherapeutic group: Other haematological agents, drugs used in hereditary angioedema, ATC code: B06AC04.

The plasma protein C1-INH is the main regulator of activation of the contact and complement systems *in vivo*. HAE patients have a heterozygous deficiency of the plasma protein C1-INH. As a result they may suffer from uncontrolled activation of contact and complement systems, with formation of inflammatory mediators, which clinically becomes manifest as the occurrence of acute angioedema attacks.

Conestat alfa, a recombinant human complement component 1 (C1) esterase inhibitor (rhC1-INH), is an analogue of human C1-INH and is obtained from the milk of rabbits expressing the gene coding for human C1-INH. The amino acid sequence of conestat alfa is identical to that of endogenous C1-INH.

C1-INH exerts an inhibitory effect on several proteases (target proteases) of the contact and complement systems. The effect of conestat alfa on the following target proteases was assessed *in vitro*: activated C1s, kallikrein, factor XIIa and factor XIa. Inhibition kinetics were found to be comparable with those observed for plasma-derived human C1-INH.

The complement component (protein) C4, is a substrate for activated C1s. Patients with HAE have low levels of C4 in the circulation. As for plasma-derived C1-INH, the pharmacodynamic effects of conestat alfa on C4 show dose-dependent restoration of complement homeostasis in HAE patients at a plasma C1-INH activity level greater than 0.7 U/ml, which is the lower limit of the normal range. In HAE patients, Ruconest at a dose of 50 U/kg increases plasma C1-INH activity level to greater than 0.7 U/ml for approximately 2 hours (see section 5.2).

The efficacy and safety of Ruconest as a treatment of acute angioedema attacks in adult and adolescent patients with HAE has been evaluated in two double blind randomized placebo controlled and four open label clinical studies. The doses evaluated in the clinical studies ranged from a single vial of 2100 U (corresponding to 18-40 U/kg), to 50 and 100 U/kg. Efficacy of Ruconest as a treatment for acute angioedema attacks was demonstrated by significantly shorter time to beginning of relief of symptoms and time to minimal symptoms and few therapeutic failures. The table below shows the results (primary and secondary endpoints) of the two randomized controlled trials:

Study	Treatment	Time (minutes) to beginning of relief median (95% CI)	Time (minutes) to minimal symptoms median (95% CI)
C1 1205 RCT	100 U/kg n =13	68 (62, 132) p = 0.001	245 (125, 270) p = 0.04
	50 U/kg n =12	122 (72, 136) p < 0.001	247 (243, 484)
	Saline n = 13	258 (240, 495)	1101 (970, 1494)
C1 1304 RCT	100 U/kg n =16	62 (40, 75) p = 0.003	480 (243, 723) p = 0.005
	Saline n = 16	508 (70, 720)	1440 (720, 2885)

The results of the open label studies were consistent with the above findings and support the repeated use of Ruconest in the treatment of subsequent attacks of angioedema.

In the randomized controlled trials 39/41 (95%) of patients treated with Ruconest reached time to beginning of relief within 4 hours. In an open label study 146/151 (97%) attacks treated with a single dose of 50 U/kg reached time to beginning of relief within 4 hours. An additional dose of 50 U/kg was administered for 17/168 (10%) attacks.

Paediatric population

Children

In an open label study with 20 children with HAE (aged 5 to 14 years), 64/67 (96%) attacks treated with a single dose of 50 U/kg reached time to beginning of relief within 4 hours. An additional dose of 50 U/kg was administered for 3/73 (4%) attacks.

Adolescents

Ten adolescent HAE patients (aged 13 to 17 years) were treated with 50 U/kg for 27 acute angioedema attacks, and 7 (aged 16 to 17 years) with 2100 U for 24 acute angioedema attacks.

The efficacy and safety results in children and adolescents were consistent with those in adults.

5.2 Pharmacokinetic properties

Distribution

No formal distribution studies have been performed. The distribution volume of conestat alfa was approximately 3 L, comparable to plasma volume.

Biotransformation and elimination

Based on animal data, conestat alfa is cleared from the circulation by the liver via receptor-mediated endocytosis followed by complete hydrolysis/degradation.

After administration of Ruconest (50 U/kg) to asymptomatic HAE patients, a C_{max} of 1.36 U/ml was observed. The elimination half-life of conestat alfa was approximately 2 hours.

Excretion

There is no excretion, as conestat alfa is cleared from the circulation via receptor-mediated endocytosis followed by complete hydrolysis/degradation in the liver.

Paediatric population

Children

After receiving a conestat alfa dose of 50 U/kg, a total of 18/20 children had concentrations of functional C1-INH that were >70% of normal (the lower limit of the normal range) at the 5-minute and/or 2-4 hour post-dose time points. The arithmetic mean functional C1-INH C_{max} for the first attack was 123% of normal (range 62% to 168%) and the AUC_{0-3} was 171% of normal (range 95% to 244%).

A population PK model shows that a dose of 50 U/kg will achieve concentrations of functional C1-INH that are >70% of normal in 96.0% of children aged 2 to ≤13 years and in 90.5% of children aged 2 to <5 years.

5.3 Preclinical safety data

Preclinical data do not indicate any safety concern for the use of conestat alfa in humans based on studies of safety pharmacology, single-dose toxicity, two-week sub-chronic toxicity and local tolerance in various animal species including rats, dogs, rabbits and cynomolgus monkeys. Genotoxic and carcinogenic potential is not expected.

Embryofoetal studies in rat and rabbit; Daily single doses of vehicle or 625 U/kg/administration of conestat alfa were administered intravenously to mated rats and rabbits. In the study in rats there were no malformed foetuses in either the conestat alfa or the control group. In a rabbit embryotoxicity study an increase in the incidence of foetal cardiac vessel defects (1.12% in the treatment group versus 0.03% in historical controls) was observed for animals that were administered conestat alfa.

6. PHARMACEUTICAL PARTICULARS

6.1 List of excipients

Sucrose
Sodium citrate (E331)
Citric acid

6.2 Incompatibilities

In the absence of compatibility studies, this medicinal product must not be mixed with other medicinal products.

6.3 Shelf life

4 years.

Reconstituted solution

Chemical and physical in-use stability has been demonstrated for 48 hours between 5°C and 25°C. From a microbiological point of view, the medicinal product should be used immediately. If not used immediately, in-use storage times and conditions prior to use are the responsibility of the user and would normally not be longer than 24 hours at 2 to 8°C, unless reconstitution has taken place in controlled and validated aseptic conditions.

6.4 Special precautions for storage

Do not store above 25°C.

Store in the original package in order to protect from light.

For storage conditions after reconstitution of the medicinal product, see section 6.3.

6.5 Nature and contents of container

2100 units of conestat alfa powder in a 25 ml vial (type 1 glass) with a stopper (siliconized chlorobutyl rubber) and a flip-off seal (aluminium and coloured plastic).

Pack size of 1.

6.6 Special precautions for disposal

Each vial of Ruconest is for single use only.

An aseptic technique should be used for reconstitution, combining and mixing the solutions.

Reconstitution

Each vial of Ruconest (2100 U) should be reconstituted with 14 ml water for injections. Water for injections should be added slowly to avoid forceful impact on the powder and mixed gently to minimise foaming of the solution. The reconstituted solution contains 150 U/ml conestat alfa and appears as a clear colourless solution.

The reconstituted solution in each vial should be visually inspected for particulate matter and discoloration. A solution exhibiting particulates or discoloration should not be used. The medicinal product should be used immediately (see section 6.3).

Any unused medicinal product or waste material should be disposed of in accordance with local requirements.

7. MARKETING AUTHORISATION HOLDER

Pharming Group N.V.
Darwinweg 24
2333 CR Leiden
The Netherlands

8. MARKETING AUTHORISATION NUMBER(S)

EU/1/10/641/001

9. DATE OF FIRST AUTHORISATION/RENEWAL OF THE AUTHORISATION

Date of first authorisation: 28 October 2010

Date of latest renewal: 18 September 2015

10. DATE OF REVISION OF THE TEXT

Detailed information on this medicinal product is available on the website of the European Medicines Agency <http://www.ema.europa.eu>.

1. NAME OF THE MEDICINAL PRODUCT

Ruconest 2100 Units powder and solvent for solution for injection.

2. QUALITATIVE AND QUANTITATIVE COMPOSITION

Powder vial:

One vial contains 2100 units of conestat alfa, corresponding to 2100 units per 14 ml after reconstitution, or a concentration of 150 units/ml.

Conestat alfa is a recombinant analogue of the human C1 esterase inhibitor (rhC1-INH) produced by recombinant DNA technology in the milk of transgenic rabbits.

1 unit of conestat alfa activity is defined as the equivalent of C1 esterase inhibiting activity present in 1 ml of pooled normal plasma.

Excipient with known effect:

Each powder vial contains approximately 19.5 mg sodium.

For the full list of excipients, see section 6.1.

3. PHARMACEUTICAL FORM

Powder and solvent for solution for injection.

White to off-white powder.

The solvent is a clear, colourless liquid.

4. CLINICAL PARTICULARS

4.1 Therapeutic indications

Ruconest is indicated for treatment of acute angioedema attacks in adults, adolescents, and children (aged 2 years and above) with hereditary angioedema (HAE) due to C1 esterase inhibitor deficiency.

4.2 Posology and method of administration

Ruconest should be initiated under the guidance and supervision of a physician experienced in the diagnosis and treatment of hereditary angioedema.

Posology in adults, adolescents and children aged 2 years and above

Body weight up to 84 kg

- One intravenous injection of 50 U/kg body weight.

Body weight of 84 kg or greater

- One intravenous injection of 4200 U (2 vials).

In the majority of cases, a single dose of Ruconest is sufficient to treat an acute angioedema attack.

In case of an insufficient clinical response, an additional dose (50 U/kg body weight up to 4200 U) can be administered (see section 5.1).

- In adults and adolescents an additional dose may be administered if the patient has not responded adequately after 120 minutes.
- In children an additional dose may be administered if the patient has not responded adequately after 60 minutes.

Not more than two doses should be administered within 24 hours.

Dose calculation

Determine the patient's body weight.

Body weight up to 84 kg

- For patients up to 84 kg calculate the volume required to be administered according to the formula below:

$$\text{Volume to be administered (ml)} = \frac{\text{body weight (kg) times 50 (U/kg)}}{150 \text{ (U/ml)}} = \frac{\text{body weight (kg)}}{3}$$

Body weight of 84 kg or greater

- For patients of 84 kg or above the volume required to be administered is 28 ml, corresponding to 4200 U (2 vials).

Paediatric population

Ruconest may be used in paediatric patients (2 years and older) at the same dose as in adults (50 U/kg body weight).

The safety and efficacy of Ruconest in children less than 2 years old have not been established. No clinical data are available.

Elderly (≥65 years old)

Data in patients older than 65 years are limited.

There is no rationale for patients older than 65 years to respond differently to Ruconest.

Renal impairment

No dose adjustment is necessary in patients with renal impairment since conestat alfa does not undergo renal clearance.

Hepatic impairment

There is no clinical experience with Ruconest in patients with hepatic impairment. Hepatic impairment may prolong the plasma half-life of conestat alfa, but this is not thought to be a clinical concern. No recommendation on a dose adjustment can be made.

Method of administration

For intravenous use.

Ruconest must be administered by a healthcare professional until the patient (or caregiver) is competent to administer after having been properly trained and in agreement with the healthcare professional.

For instructions on reconstitution of Ruconest before administration, see section 6.6.

The required volume of the reconstituted solution should be administered as a slow intravenous injection over approximately 5 minutes.

4.3 Contraindications

- Known or suspected allergy to rabbits (see section 4.4)
- Hypersensitivity to the active substance or to any of the excipients listed in section 6.1

4.4 Special warnings and precautions for use

Traceability

In order to improve the traceability of biological medicinal products, the name and the batch number of the administered products should be clearly recorded.

Conestat alfa is derived from milk of transgenic rabbits and contains traces of rabbit protein. Before initiating treatment with Ruconest, patients should be queried about prior exposure to rabbits and signs and symptoms suggestive of an allergic reaction.

Hypersensitivity reactions cannot be excluded and may have symptoms similar to angioedema attacks. All patients must be closely monitored and carefully observed for any symptoms of hypersensitivity during and after the administration period. Patients should be informed of the early signs of hypersensitivity reactions, e.g., hives, generalised urticaria, tightness of the chest, wheezing, hypotension and anaphylaxis. If these symptoms occur after administration, they should alert their physician.

In case of anaphylactic reactions or shock, emergency medical treatment should be administered.

Although cross-reactivity between cow milk and rabbit milk is considered unlikely, the possibility of such a cross-reactivity in a patient who has evidence of clinical allergy to cow milk cannot be excluded and the patient should be observed for signs and symptoms of hypersensitivity following Ruconest administration.

Thromboembolic events

Serious arterial and venous thromboembolic (TE) events have been reported at the recommended dose of plasma derived C1 esterase inhibitor products in patients with known risk factors (e.g., indwelling catheters, prior history of thrombosis, underlying atherosclerosis, use of oral contraceptives or certain androgens, morbid obesity, immobility). Patients with known risk factors should be monitored closely.

Sodium

Each vial of Ruconest contains 19.5 mg of sodium. To be taken into consideration by patients on a controlled sodium diet.

Home-treatment and self-administration

There are limited data on the use of this medicinal product in home- or self-administration. Potential risks associated with home-treatment are related to the administration itself as well as the handling of adverse reactions, particularly hypersensitivity. The decision on the use of home-treatment for an individual patient should be made by the treating physician, who should ensure that appropriate training is provided and the use reviewed at intervals.

4.5 Interaction with other medicinal products and other forms of interaction

No interaction studies have been performed.

Scientific literature indicates an interaction of tissue-type plasminogen activator (tPA) and C1-INH containing medicinal products. Ruconest should not be administered simultaneously with tPA.

4.6 Fertility, pregnancy and lactation

Pregnancy and breast-feeding

There is no experience with the use of Ruconest in pregnant and breast-feeding women.

In one animal study reproductive toxicity was observed (see section 5.3). Ruconest is not recommended for use during pregnancy or breast-feeding, unless the treating physician judges the benefits to outweigh the possible risks.

Fertility

There are no data on the effects of Ruconest on male or female fertility.

4.7 Effects on ability to drive and use machines

Based on the known pharmacology and adverse reaction profile of Ruconest, effects on the ability to drive and use machines are not expected. However headache, vertigo and dizziness have been reported following the use of Ruconest, but may also occur as a result of an attack of HAE. Patients should be advised not to drive and use machines if they experience headache, vertigo or dizziness.

4.8 Undesirable effects

Summary of the safety profile

One case of hypersensitivity was observed in clinical trials with Ruconest. The most common adverse

reaction observed after administration of Ruconest is nausea.

Tabulated lists of adverse reactions

Adverse reactions reported with Ruconest in the treatment of acute HAE attacks obtained from clinical trials and post-marketing surveillance are tabulated below. In clinical trials, the incidence of adverse reactions was similar for all dose groups and did not increase upon repeated administrations.

The frequency of adverse reactions listed below is defined using the following convention:

Very common ($\geq 1/10$),

Common ($\geq 1/100$ to $< 1/10$),

Uncommon ($\geq 1/1,000$ to $< 1/100$),

Rare ($\geq 1/10,000$ to $< 1/1,000$),

Very rare ($< 1/10,000$),

Not known (cannot be estimated from the available data).

System Organ Class	Adverse reaction	Frequency
Nervous system disorders	Headache	Uncommon
	Vertigo	Uncommon
	Hypoaesthesia	Uncommon
	Dizziness	Uncommon
Ear and labyrinth disorders	Auricular swelling	Uncommon
Respiratory, thoracic and mediastinal disorders	Throat irritation	Uncommon
Gastrointestinal disorders	Nausea	Common
	Diarrhoea	Uncommon
	Abdominal discomfort	Uncommon
	Oral paraesthesia	Uncommon
Skin and subcutaneous tissue disorders	Urticaria	Uncommon
Immune system disorders	Anaphylaxis*	Uncommon
	Hypersensitivity reactions*	Not known

*Further information is found in section 4.4

Paediatric population

In the clinical development program, 37 children and adolescents (aged 5 to 17 years) with HAE were treated for 124 acute angioedema attacks. Frequency, type and severity of adverse reactions in children and adolescents were similar to those in adults.

Reporting of suspected adverse reactions

Reporting suspected adverse reactions after authorisation of the medicinal product is important. It allows continued monitoring of the benefit/risk balance of the medicinal product. Healthcare professionals are asked to report any suspected adverse reactions via the national reporting system listed in [Appendix V](#).

4.9 Overdose

No clinical information on overdose is available.

5. PHARMACOLOGICAL PROPERTIES

5.1 Pharmacodynamic properties

Pharmacotherapeutic group: Other haematological agents, drugs used in hereditary angioedema, ATC code: B06AC04.

The plasma protein C1-INH is the main regulator of activation of the contact and complement systems *in vivo*. HAE patients have a heterozygous deficiency of the plasma protein C1-INH. As a result they may suffer from uncontrolled activation of contact and complement systems, with formation of inflammatory mediators, which clinically becomes manifest as the occurrence of acute angioedema attacks.

Conestat alfa, a recombinant human complement component 1 (C1) esterase inhibitor (rhC1-INH), is an analogue of human C1-INH and is obtained from the milk of rabbits expressing the gene coding for human C1-INH. The amino acid sequence of conestat alfa is identical to that of endogenous C1-INH.

C1-INH exerts an inhibitory effect on several proteases (target proteases) of the contact and complement systems. The effect of conestat alfa on the following target proteases was assessed *in vitro*: activated C1s, kallikrein, factor XIIa and factor XIa. Inhibition kinetics were found to be comparable with those observed for plasma-derived human C1-INH.

The complement component (protein) C4, is a substrate for activated C1s. Patients with HAE have low levels of C4 in the circulation. As for plasma-derived C1-INH, the pharmacodynamic effects of conestat alfa on C4 show dose-dependent restoration of complement homeostasis in HAE patients at a plasma C1-INH activity level greater than 0.7 U/ml, which is the lower limit of the normal range. In HAE patients, Ruconest at a dose of 50 U/kg increases plasma C1-INH activity level to greater than 0.7 U/ml for approximately 2 hours (see section 5.2).

The efficacy and safety of Ruconest as a treatment of acute angioedema attacks in adult and adolescent patients with HAE has been evaluated in two double blind randomized placebo controlled and four open label clinical studies. The doses evaluated in the clinical studies ranged from a single vial of 2100 U (corresponding to 18-40 U/kg), to 50 and 100 U/kg. Efficacy of Ruconest as a treatment for acute angioedema attacks was demonstrated by significantly shorter time to beginning of relief of symptoms and time to minimal symptoms and few therapeutic failures. The table below shows the results (primary and secondary endpoints) of the two randomized controlled trials:

Study	Treatment	Time (minutes) to beginning of relief median (95% CI)	Time (minutes) to minimal symptoms median (95% CI)
C1 1205 RCT	100 U/kg n =13	68 (62, 132) p = 0.001	245 (125, 270) p = 0.04
	50 U/kg n =12	122 (72, 136) p < 0.001	247 (243, 484)
	Saline n = 13	258 (240, 495)	1101 (970, 1494)
C1 1304 RCT	100 U/kg n =16	62 (40, 75) p = 0.003	480 (243, 723) p = 0.005
	Saline n = 16	508 (70, 720)	1440 (720, 2885)

The results of the open label studies were consistent with the above findings and support the repeated use of Ruconest in the treatment of subsequent attacks of angioedema.

In the randomized controlled trials 39/41 (95%) of patients treated with Ruconest reached time to beginning of relief within 4 hours. In an open label study 146/151 (97%) attacks treated with a single dose of 50 U/kg reached time to beginning of relief within 4 hours. An additional dose of 50 U/kg was administered for 17/168 (10%) attacks.

Paediatric population

Children

In an open label study with 20 children with HAE (aged 5 to 14 years), 64/67 (96%) attacks treated with a single dose of 50 U/kg reached time to beginning of relief within 4 hours. An additional dose of 50 U/kg was administered for 3/73 (4%) attacks.

Adolescents

Ten adolescent HAE patients (aged 13 to 17 years) were treated with 50 U/kg for 27 acute angioedema attacks, and 7 (aged 16 to 17 years) with 2100 U for 24 acute angioedema attacks.

The efficacy and safety results in children and adolescents were consistent with those in adults.

5.2 Pharmacokinetic properties

Distribution

No formal distribution studies have been performed. The distribution volume of conestat alfa was approximately 3 L, comparable to plasma volume.

Biotransformation and elimination

Based on animal data, conestat alfa is cleared from the circulation by the liver via receptor-mediated endocytosis followed by complete hydrolysis/degradation.

After administration of Ruconest (50 U/kg) to asymptomatic HAE patients, a C_{max} of 1.36 U/ml was observed. The elimination half-life of conestat alfa was approximately 2 hours.

Excretion

There is no excretion, as conestat alfa is cleared from the circulation via receptor-mediated endocytosis followed by complete hydrolysis/degradation in the liver.

Paediatric population

Children

After receiving a conestat alfa dose of 50 U/kg, a total of 18/20 children had concentrations of functional C1-INH that were >70% of normal (the lower limit of the normal range) at the 5-minute and/or 2-4 hour post-dose time points. The arithmetic mean functional C1-INH C_{max} for the first attack was 123% of normal (range 62% to 168%) and the AUC_{0-3} was 171% of normal (range 95% to 244%).

A population PK model shows that a dose of 50 U/kg will achieve concentrations of functional C1-INH that are >70% of normal in 96.0% of children aged 2 to ≤ 13 years and in 90.5% of children aged 2 to <5 years.

5.3 Preclinical safety data

Preclinical data do not indicate any safety concern for the use of conestat alfa in humans based on studies of safety pharmacology, single-dose toxicity, two-week sub-chronic toxicity and local tolerance in various animal species including rats, dogs, rabbits and cynomolgus monkeys. Genotoxic and carcinogenic potential is not expected.

Embryofoetal studies in rat and rabbit; Daily single doses of vehicle or 625 U/kg/administration of conestat alfa were administered intravenously to mated rats and rabbits. In the study in rats there were no malformed foetuses in either the conestat alfa or the control group. In a rabbit embryotoxicity study an increase in the incidence of foetal cardiac vessel defects (1.12% in the treatment group versus 0.03% in historical controls) was observed for animals that were administered conestat alfa.

6. PHARMACEUTICAL PARTICULARS

6.1 List of excipients

Powder vial:

Sucrose
Sodium citrate (E331)
Citric acid

Solvent vial:

Water for injections

6.2 Incompatibilities

In the absence of compatibility studies, this medicinal product must not be mixed with other medicinal products.

6.3 Shelf life

4 years.

Reconstituted solution

Chemical and physical in-use stability has been demonstrated for 48 hours between 5°C and 25°C. From a microbiological point of view, the medicinal product should be used immediately. If not used immediately in-use storage times and conditions prior to use are the responsibility of the user and would normally not be longer than 24 hours at 2 to 8°C, unless reconstitution has taken place in controlled and validated aseptic conditions.

6.4 Special precautions for storage

Powder vial:

Do not store above 25°C.

Store in the original package in order to protect from light.

Solvent vial:

Do not store above 25°C.

For storage conditions after reconstitution of the medicinal product, see section 6.3.

6.5 Nature and contents of container

Powder vial: 2100 units of conestat alfa powder in a vial (type 1 glass) with a stopper (siliconized chlorobutyl rubber) and a flip-off seal (aluminium and coloured plastic).

Solvent vial: 20 ml of water for injections in a vial (type 1 glass) with a stopper (siliconized chlorobutyl rubber) and a flip-off seal (aluminium and coloured plastic).

Administration kit:

- 1 powder vial
- 1 solvent vial
- 2 vial adapters
- 1 syringe
- 1 infusion set with 35 cm tubing and 25G needle
- 2 alcohol pads
- 1 sterile non-woven pad
- 1 self-adhesive plaster

6.6 Special precautions for disposal and other handling

Preparation and handling

Each vial of Ruconest is for single use only.

Ruconest is intended for intravenous administration after reconstitution with water for injections. An aseptic

technique should be used for reconstitution, combining and mixing the solutions.

Reconstitution

1. Each vial of Ruconest (2100 U) should be reconstituted with 14 ml of solvent.
2. Disinfect the rubber stoppers of the powder and solvent vials and put a vial adapter onto each solvent and powder vial until it snaps onto the vial neck.
3. Attach the syringe to the adapter on the solvent vial and turn clockwise until it locks. Draw in 14 ml of solvent. Unlock the syringe from the adapter by turning counter clockwise and discard the vial with adapter.
4. Attach the syringe with solvent to the adapter on the powder vial and turn clockwise until it locks. The solvent should be added slowly to avoid forceful impact on the powder and mixed gently to minimise foaming of the solution. Leave the syringe on the adapter. Repeat steps 3 and 4 if you need to prepare a second solution (this requires a second kit).
5. The reconstituted solution contains 150 U/ml conestat alfa and appears as a clear colourless solution. The reconstituted solution in each vial should be visually inspected for particulate matter and discoloration. A solution exhibiting particulates or discoloration should not be used. Small amounts of foam are acceptable. The medicinal product should be used immediately (see section 6.3).

Administration

1. Draw in the required volume of prepared solution. Never exceed 14 ml per syringe. Unlock the syringe(s) by turning counter clockwise and discard the vial with adapter.
2. Attach the infusion set to the syringe and turn clockwise until it locks. Hold the syringe with the tip pointing upwards and gently press the plunger to fill the infusion set with the solution.
3. Disinfect the injection site with an alcohol pad. Remove the needle cap from the needle of the infusion set and carefully insert the needle into the vein.
4. Ensure that the tourniquet is released. Gently inject the solution into the vein – inject over about 5 minutes.
5. If two syringes were prepared: fold over the tubing to prevent backflow, unscrew the empty syringe from the infusion set (counter clockwise) and immediately replace it with the second syringe. Gently inject the solution of the second syringe.

Disposal

Please safely dispose of the used infusion set with needle, any unused solution, the syringe and the empty vial in an appropriate medical waste container as these materials may hurt others if not disposed of properly. Do not reuse equipment.

7. MARKETING AUTHORISATION HOLDER

Pharming Group N.V.
Darwinweg 24
2333 CR Leiden
The Netherlands

8. MARKETING AUTHORISATION NUMBER(S)

EU/1/10/641/002

9. DATE OF FIRST AUTHORISATION/RENEWAL OF THE AUTHORISATION

Date of first authorisation: 28 October 2010
Date of latest renewal: 18 September 2015

10. DATE OF REVISION OF THE TEXT

Detailed information on this medicinal product is available on the website of the European Medicines Agency <http://www.ema.europa.eu>.

ANNEX II

- A. MANUFACTURER(S) OF THE BIOLOGICAL ACTIVE SUBSTANCE(S) AND MANUFACTURER(S) RESPONSIBLE FOR BATCH RELEASE**
- B. CONDITIONS OR RESTRICTIONS REGARDING SUPPLY AND USE**
- C. OTHER CONDITIONS AND REQUIREMENTS OF THE MARKETING AUTHORISATION**
- D. CONDITIONS OR RESTRICTIONS WITH REGARD TO THE SAFE AND EFFECTIVE USE OF THE MEDICINAL PRODUCT**

A. MANUFACTURER(S) OF THE BIOLOGICAL ACTIVE SUBSTANCE(S) AND MANUFACTURER(S) RESPONSIBLE FOR BATCH RELEASE

Name and address of the manufacturers of the biological active substance

Pharming Technologies B.V.
Darwinweg 24
2333 CR Leiden
The Netherlands

Broekman Institute B.V.
Schoolstraat 21
5711 CP Someren
The Netherlands

Sanofi-Chimie
Route d'Avignon
Aramon 30390
France

Name and address of the manufacturer responsible for batch release

Pharming Technologies B.V.
Darwinweg 24
2333 CR Leiden
The Netherlands

B. CONDITIONS OR RESTRICTIONS REGARDING SUPPLY AND USE

Medicinal product subject to restricted medical prescription (see Annex I: Summary of Product Characteristics, section 4.2).

C. OTHER CONDITIONS AND REQUIREMENTS OF THE MARKETING AUTHORISATION

• **Periodic safety update reports (PSURs)**

The requirements for submission of PSURs for this medicinal product are set out in the list of Union reference dates (EURD list) provided for under Article 107c(7) of Directive 2001/83/EC and any subsequent updates published on the European medicines web-portal.

D. CONDITIONS OR RESTRICTIONS WITH REGARD TO THE SAFE AND EFFECTIVE USE OF THE MEDICINAL PRODUCT

• **Risk management plan (RMP)**

The marketing authorisation holder (MAH) shall perform the required pharmacovigilance activities and interventions detailed in the agreed RMP presented in Module 1.8.2 of the marketing authorisation and any agreed subsequent updates of the RMP.

An updated RMP should be submitted:

- At the request of the European Medicines Agency;
- Whenever the risk management system is modified, especially as the result of new information being received that may lead to a significant change to the benefit/risk profile or as the result of an important (pharmacovigilance or risk minimisation) milestone being reached.

- **Additional risk minimisation measures**

Prior to launch of the product in each member state, the MAH shall agree the content and format of the educational material with the national competent authority (NCA).

The MAH should ensure that, at launch, all Healthcare Professionals who are expected to prescribe Ruconest are provided with an educational pack.

The educational pack should contain the following:

- Summary of Product Characteristics and Package Leaflet for Ruconest
- Educational material for the Healthcare Professional.
- Educational material for non-Healthcare Professionals.
- Diary to be given to patients before they receive Ruconest.
- Copies of the patient card to be given to patients before they receive Ruconest.

The educational material for the Healthcare Professional should include information on the following key elements:

- That Ruconest should be initiated under the guidance and supervision of a physician experienced in the diagnosis and treatment of hereditary angioedema.
- That patients treated with Ruconest should be monitored for clinical signs and symptoms of hypersensitivity during administration. Emergency medical treatment should be available immediately to be administered in case of anaphylactic reactions or shock.
- The fact that Ruconest is derived from milk of transgenic rabbits and contains trace of rabbit proteins (Host -Related Impurities, HRI).
- That Ruconest is contra indicated in all patients with known or suspected rabbit allergy.
- That patients with clinical evidence of cow's milk allergy may have antibodies cross reacting with the rabbit milk impurities in Ruconest.
- The need to inform patients about the early signs of hypersensitivity reactions including hives, generalised urticaria, tightness of the chest, wheezing, hypotension and anaphylaxis, and that they should alert their physician if these symptoms occur.
- The potential risk of an immune complex-mediated type III hypersensitivity reaction due to the formation of antibodies directed against HRI. Advice about the immunogenicity laboratory testing program for detecting these antibodies for following up suspected immune complex-mediated disease, and about the procedure to follow for the collection and shipment of a blood sample to the company's central laboratory. This testing should be provided free of charge.
- The risk of formation of anti-C1-INH antibodies and therefore the potential risk of formation of neutralising antibodies. Advice about the immunogenicity laboratory testing program for these antibodies provided by the company for following up suspected emergence of neutralising antibodies and information about the procedure to follow for the collection and shipment of a blood sample to the company's central laboratory. This testing should be provided free of charge.
- There are limited data on the use of this medicinal product in home or self-administration.
- The decision on the use of home treatment for an individual patient should be made by the treating physician.
- Use of Ruconest is only approved in acute attacks of hereditary angioedema.

- It is the responsibility of the physician to provide the patient or a caregiver with instructions and training on administration outside of a clinic setting.
- The training to be provided should address the following elements
 - Precaution for storage
 - Dose calculation and indication (i.e. only acute HAE attacks)
 - Preparation of one dose of Ruconest (50 U/kg, up to 4200 U) by reconstituting one or two vials
 - Method of reconstitution of each powder vial
 - Technique of intravenous injection
 - Guidance on use of a second dose of Ruconest
 - Instruction to immediately seek medical attention in case of failure to gain venous access, in case of lack of efficacy, in the event of any adverse reaction including hypersensitivity, or after self-administering Ruconest for an acute laryngeal HAE attack.
 - Instruction in handling possible adverse drug reactions including an acute hypersensitivity reaction
 - Information on the need to keep a diary to document each treatment administered at home and to bring it at each visit. The information recorded should include:
 - Date and time of treatment
 - Batch number and dose
 - Response to treatment
 - Any adverse events
- It is the responsibility of the physician to verify that all the necessary skills have been acquired by the non-Healthcare Professional and that Ruconest may be safely and effectively administered outside of a Healthcare Professional setting.
- The existence of a postmarketing registry in which healthcare professionals are encouraged to enter patients.

The educational material for non-Healthcare Professionals should include information on the following key elements:

- There are limited data on the use of this medicinal product in home or self-administration.
- For some patients the physician may decide that Ruconest may be administered outside of a clinic setting by a non-Healthcare Professional such as a family member or by self-administration.
- Use of Ruconest is only approved in acute attacks of hereditary angioedema.
- Necessary skills have to be acquired by non-Healthcare Professionals before Ruconest may be safely and effectively administered outside of a Healthcare Professional setting.
- A physician will provide training on the following elements:
 - Precaution for storage
 - Dose calculation and indication (i.e. only acute HAE attacks)
 - Preparation of one dose of Ruconest (50 U/kg, up to 4200 U) by reconstituting one or two vials
 - Method of reconstitution of each powder vial
 - Technique of intravenous injection
 - Method and rate of administration of one dose of Ruconest
 - Guidance on use of a second dose of Ruconest
 - Instruction to immediately seek medical attention in case of failure to gain venous access, in case of lack of efficacy, in the event of any adverse reaction including hypersensitivity, or after self-administering Ruconest for an acute laryngeal HAE attack.
 - Information on the need to keep a diary to document each treatment administered at home and to bring it at each visit. The information collected should include:
 - Date and time of treatment
 - Batch number and dose

- Response to treatment
- Any adverse events

The patient diary should contain the following key elements:

- Date and time of treatment
- Batch number and dose
- Response to treatment
- Any adverse events

The patient card should contain the following key elements:

- That they are receiving Ruconest for treatment of an acute attack of hereditary angioedema.
- That Ruconest is derived from milk of transgenic rabbits and contains trace of rabbit proteins.
- The importance of monitoring for clinical signs and symptoms of hypersensitivity and that patients should immediately seek medical care if they develop such symptoms during or after receiving Ruconest.
- That they should be asked to carry the card and always show it to any Healthcare Professional treating them for acute attacks of hereditary angioedema.

ANNEX III
LABELLING AND PACKAGE LEAFLET

A. LABELLING

PARTICULARS TO APPEAR ON THE OUTER PACKAGING

VIAL CARTON

1. NAME OF THE MEDICINAL PRODUCT

Ruconest 2100 Units powder for solution for injection
conestat alfa

2. STATEMENT OF ACTIVE SUBSTANCE(S)

One vial contains 2100 U of conestat alfa, corresponding to 2100 U/14 ml after reconstitution, or a concentration of 150 U/ml.

3. LIST OF EXCIPIENTS

Excipients:
Sucrose,
Sodium Citrate (E331),
Citric Acid.

4. PHARMACEUTICAL FORM AND CONTENTS

Powder for solution for injection
1 vial

5. METHOD AND ROUTE(S) OF ADMINISTRATION

Read the package leaflet before use.
For intravenous use.

6. SPECIAL WARNING THAT THE MEDICINAL PRODUCT MUST BE STORED OUT OF THE SIGHT AND REACH OF CHILDREN

Keep out of the sight and reach of children.

7. OTHER SPECIAL WARNING(S), IF NECESSARY

8. EXPIRY DATE

EXP

9. SPECIAL STORAGE CONDITIONS

Do not store above 25°C.
Store in the original package in order to protect from light.

10. SPECIAL PRECAUTIONS FOR DISPOSAL OF UNUSED MEDICINAL PRODUCTS OR WASTE MATERIALS DERIVED FROM SUCH MEDICINAL PRODUCTS, IF APPROPRIATE

11. NAME AND ADDRESS OF THE MARKETING AUTHORISATION HOLDER

Pharming Group N.V.
Darwinweg 24
2333 CR Leiden
The Netherlands

12. MARKETING AUTHORISATION NUMBER(S)

EU/1/10/641/001

13. BATCH NUMBER

Lot

14. GENERAL CLASSIFICATION FOR SUPPLY

Medicinal product subject to medical prescription.

15. INSTRUCTIONS ON USE

16. INFORMATION IN BRAILLE

Ruconest

17. UNIQUE IDENTIFIER – 2D BARCODE

2D barcode carrying the unique identifier included.

18. UNIQUE IDENTIFIER - HUMAN READABLE DATA

PC:
SN:
NN:

PARTICULARS TO APPEAR ON THE OUTER PACKAGING

ADMINISTRATION KIT OUTER CARTON

1. NAME OF THE MEDICINAL PRODUCT

Ruconest 2100 Units powder and solvent for solution for injection
conestat alfa

2. STATEMENT OF ACTIVE SUBSTANCE(S)

One powder vial contains 2100 U of conestat alfa, corresponding to 2100 U/14 ml after reconstitution, or a concentration of 150 U/ml.

3. LIST OF EXCIPIENTS

Excipients:
Sucrose,
Sodium Citrate (E331),
Citric Acid.

4. PHARMACEUTICAL FORM AND CONTENTS

Powder and solvent for solution for injection

One administration kit contains:

1 powder vial
1 solvent vial
2 vial adapters
1 syringe
1 infusion set with needle
2 alcohol pads
1 sterile non-woven pad
1 adhesive plaster

5. METHOD AND ROUTE(S) OF ADMINISTRATION

Read the package leaflet before use.
For intravenous use.
For single use.

6. SPECIAL WARNING THAT THE MEDICINAL PRODUCT MUST BE STORED OUT OF THE SIGHT AND REACH OF CHILDREN

Keep out of the sight and reach of children.

7. OTHER SPECIAL WARNING(S), IF NECESSARY

8. EXPIRY DATE

EXP

9. SPECIAL STORAGE CONDITIONS

Do not store above 25 °C.
Keep the powder vial in the outer carton in order to protect from light.

10. SPECIAL PRECAUTIONS FOR DISPOSAL OF UNUSED MEDICINAL PRODUCTS OR WASTE MATERIALS DERIVED FROM SUCH MEDICINAL PRODUCTS, IF APPROPRIATE

11. NAME AND ADDRESS OF THE MARKETING AUTHORISATION HOLDER

Pharming Group N.V.
Darwinweg 24
2333 CR Leiden
The Netherlands

12. MARKETING AUTHORISATION NUMBER(S)

EU/1/10/641/002

13. BATCH NUMBER

Lot

14. GENERAL CLASSIFICATION FOR SUPPLY

15. INSTRUCTIONS ON USE

16. INFORMATION IN BRAILLE

Ruconest

17. UNIQUE IDENTIFIER – 2D BARCODE

2D barcode carrying the unique identifier included.

18. UNIQUE IDENTIFIER - HUMAN READABLE DATA

PC:
SN:
NN:

PARTICULARS TO APPEAR ON THE OUTER PACKAGING

ADMINISTRATION KIT VIAL CARTON

1. NAME OF THE MEDICINAL PRODUCT

Ruconest 2100 Units powder for solution for injection
conestat alfa

2. STATEMENT OF ACTIVE SUBSTANCE(S)

One vial contains 2100 U of conestat alfa, corresponding to 2100 U/14 ml after reconstitution, or a concentration of 150 U/ml.

3. LIST OF EXCIPIENTS

Excipients:
Sucrose,
Sodium Citrate (E331),
Citric Acid.

4. PHARMACEUTICAL FORM AND CONTENTS

Powder for solution for injection
1 vial

5. METHOD AND ROUTE(S) OF ADMINISTRATION

Read the package leaflet before use.
For intravenous use.

6. SPECIAL WARNING THAT THE MEDICINAL PRODUCT MUST BE STORED OUT OF THE SIGHT AND REACH OF CHILDREN

Keep out of the sight and reach of children.

7. OTHER SPECIAL WARNING(S), IF NECESSARY

8. EXPIRY DATE

EXP

9. SPECIAL STORAGE CONDITIONS

Do not store above 25°C.
Keep the vial in the original package in order to protect from light.

10. SPECIAL PRECAUTIONS FOR DISPOSAL OF UNUSED MEDICINAL PRODUCTS OR WASTE MATERIALS DERIVED FROM SUCH MEDICINAL PRODUCTS, IF APPROPRIATE

11. NAME AND ADDRESS OF THE MARKETING AUTHORISATION HOLDER

Pharming Group N.V.
Darwinweg 24
2333 CR Leiden
The Netherlands

12. MARKETING AUTHORISATION NUMBER(S)

EU/1/10/641/002

13. BATCH NUMBER

Lot

14. GENERAL CLASSIFICATION FOR SUPPLY

15. INSTRUCTIONS ON USE

16. INFORMATION IN BRAILLE

Ruconest

17. UNIQUE IDENTIFIER – 2D BARCODE

18. UNIQUE IDENTIFIER - HUMAN READABLE DATA

MINIMUM PARTICULARS TO APPEAR ON SMALL IMMEDIATE PACKAGING UNITS

POWDER VIAL LABEL

1. NAME OF THE MEDICINAL PRODUCT AND ROUTE(S) OF ADMINISTRATION

Ruconest 2100 Units powder for solution for injection
conestat alfa
For IV use.

2. METHOD OF ADMINISTRATION

3. EXPIRY DATE

EXP

4. BATCH NUMBER

Lot

5. CONTENTS BY WEIGHT, BY VOLUME OR BY UNIT

2100 U of conestat alfa.
After reconstitution with 14 ml water for injections, the solution contains 150 U conestat alfa per ml.

6. OTHER

MINIMUM PARTICULARS TO APPEAR ON SMALL IMMEDIATE PACKAGING UNITS

SOLVENT VIAL LABEL

1. NAME OF THE MEDICINAL PRODUCT AND ROUTE(S) OF ADMINISTRATION

Solvent for Ruconest
Water for injections

2. METHOD OF ADMINISTRATION

3. EXPIRY DATE

EXP

4. BATCH NUMBER

Lot

5. CONTENTS BY WEIGHT, BY VOLUME OR BY UNIT

20 ml

6. OTHER

B. PACKAGE LEAFLET

Package leaflet: Information for the patient

Ruconest 2100 Units powder for solution for injection conestat alfa

Read all of this leaflet carefully before you start using this medicine because it contains important information for you.

- Keep this leaflet. You may need to read it again.
- If you have any further questions, ask your doctor.
- This medicine has been prescribed for you only. Do not pass it on to others. It may harm them, even if their signs of illness are the same as yours.
- If you get any side effects, talk to your doctor. This includes any possible side effects not listed in this leaflet. See section 4.

What is in this leaflet

1. What Ruconest is and what it is used for
2. What you need to know before you use Ruconest
3. How to use Ruconest
4. Possible side effects
5. How to store Ruconest
6. Contents of the pack and other information

1. What Ruconest is and what it is used for

Ruconest contains conestat alfa as the active substance. Conestat alfa is a recombinant (not blood-derived) form of human C1 inhibitor (rhC1-INH).

Ruconest is to be used by adults, adolescents, and children (aged 2 years and above) with a rare inherited blood disorder, called Hereditary Angioedema (HAE). These patients have a shortage of the C1 inhibitor protein in their blood. This can lead to repeated attacks of swelling, pain in the abdomen, difficulty breathing and other symptoms.

The administration of Ruconest is to resolve the shortage of C1 inhibitor and will lead to reduction of symptoms of an acute attack of HAE.

2. What you need to know before you use Ruconest

Do not use Ruconest

- If you are or think you are allergic to rabbits.
- If you are allergic to conestat alfa or any of the other ingredients of this medicine (listed in section 6).

Warnings and precautions

Talk to your doctor before using Ruconest.

If you experience allergic reactions e.g. hives, rash, itching, dizziness, wheezing, difficulty breathing or your tongue swells up following the administration of Ruconest, you should seek emergency medical assistance so that symptoms of your allergic reaction can be treated urgently.

Before you start treatment with Ruconest, it is important that you tell your doctor if you have, or have had, problems with your blood clotting (thrombotic events). You will be carefully monitored if this is the case.

Hypersensitivity reactions cannot be excluded and may have symptoms similar to angioedema attacks.

Children and adolescents

Do not give this medicine to children under 2 years old. Ruconest has not been studied in children younger than 5 years of age. Your doctor will determine whether treatment of your child with Ruconest is appropriate. Additional monitoring of your child for symptoms of allergic reactions during and after administration is needed.

Other medicines and Ruconest

Tell your doctor if you are taking, have recently taken or might take any other medicines. If you are receiving tissue type plasminogen activator as acute treatment for blood clots, you should not be treated with Ruconest at the same time.

Pregnancy and breast-feeding

It is not recommended to use Ruconest during pregnancy or breast-feeding. If you plan becoming pregnant, discuss with your doctor before starting to use Ruconest.

Driving and using machines

Do not drive or use machinery if you feel dizzy or suffer from headache after using Ruconest.

Ruconest contains sodium (19.5 mg per vial)

This should be taken into consideration by patients on a controlled sodium diet.

3. How to use Ruconest

Ruconest will be initiated by a doctor who is specialised in the diagnosis and treatment of hereditary angioedema.

Ruconest will be given to you directly into a vein over a period of approximately 5 minutes by your doctor or by a nurse. Your dose, up to 2 vials, will be worked out based on your weight.

Most of the time a single dose is sufficient. Your doctor may decide that an additional dose should be administered if your symptoms do not improve after 120 minutes (for adults and adolescents) or 60 minutes (for children). No more than 2 doses should be given within 24 hours.

The instructions for use are clearly described in the doctor's information leaflet and are attached.

If you have any further questions on the use of this medicine, ask your doctor or nurse.

4. Possible side effects

Like all medicines, this medicine can cause side effects, although not everybody gets them.

If your symptoms get worse and/or you develop a rash, tingling, difficulty breathing or your face or tongue swells up, get medical attention **immediately**. **This may indicate that you have developed an allergy to Ruconest.**

Some side effects may occur during treatment with Ruconest:

Common: may affect up to 1 in 10 people

- Nausea

Uncommon: may affect up to 1 in 100 people

- Abdominal pain, diarrhoea
- Sensation of tingling, prickling or numbness in the mouth
- Headache, dizziness
- Reduced sense of touch or sensation in skin or limbs
- Throat irritation
- Hives

- Swelling of the ears or the area around the ears
- Allergic shock

Not known: the frequency is not known

- Hypersensitivity reactions

Reporting of side effects

If you get any side effects, talk to your doctor. This includes any possible side effects not listed in the leaflet. You can also report side effects directly via the national reporting system listed in [Appendix V](#). By reporting side effects you can help provide more information on the safety of this medicine.

5. How to store Ruconest

Keep this medicine out of the sight and reach of children.

Do not use this medicine after the expiry date which is stated on the carton and on the label of the vial after EXP. The expiry date refers to the last day of that month.

Do not store above 25°C.

Store in the original package in order to protect from light.

Before Ruconest can be administered, it needs to be dissolved in water for injections, by a healthcare professional.

Once reconstituted, the product should be used immediately.

Do not use this medicine if you notice particles in the solution or if the solution is discoloured.

6. Contents of the pack and other information

What Ruconest contains

The active substance is conestat alfa. Each vial contains 2100 units of conestat alfa, corresponding to 2100 units per 14 ml after reconstitution, or a concentration of 150 units/ml.

The other ingredients are sucrose, sodium citrate (E331) and citric acid.

What Ruconest looks like and contents of the pack

Ruconest is presented as a single glass vial containing a white to off-white powder for solution for injection. After dissolving the powder in water for injections, the solution is clear and colourless.

Ruconest is supplied in a carton box containing one vial.

Marketing Authorisation Holder and Manufacturer

Marketing Authorisation Holder:

Pharming Group N.V.

Darwinweg 24

2333 CR Leiden

The Netherlands

Manufacturer:

Pharming Technologies B.V.

Darwinweg 24

2333 CR Leiden

The Netherlands

This leaflet was last revised in

Detailed information on this medicine is available on the European Medicines Agency web site:
<http://www.ema.europa.eu>.

The following information is intended for healthcare professionals only:

POSODOLOGY AND METHOD OF ADMINISTRATION

Posology

Body weight up to 84 kg

- One intravenous injection of 50 U/kg body weight.

Body weight of 84 kg or greater

- One intravenous injection of 4200 U (two vials).

In the majority of cases a single dose of Ruconest is sufficient to treat an acute angioedema attack.

In case of an insufficient clinical response, an additional dose (50 U/kg body weight up to 4200 U) can be administered.

Not more than two doses should be administered within 24 hours.

Dose calculation

Determine the patient's body weight.

Body weight up to 84 kg

- For patients up to 84 kg calculate the volume required to be administered according to the formula below:

$$\text{Volume to be administered (ml)} = \frac{\text{body weight (kg) times 50 (U/kg)}}{150 \text{ (U/ml)}} = \frac{\text{body weight (kg)}}{3}$$

Body weight of 84 kg or greater

- For patients of 84 kg or above the volume required to be administered is 28 ml, corresponding to 4200 U (2 vials).

Reconstitute *each vial* with 14 ml water for injections (see section on Reconstitution below).

The reconstituted solution in each vial contains 2100 U conestat alfa at 150 U/ml.

The required volume of the reconstituted solution should be administered as a slow intravenous injection over approximately 5 minutes.

SPECIAL PRECAUTIONS FOR DISPOSAL AND OTHER HANDLING

Each vial of Ruconest is for single use only.

An aseptic technique should be used for reconstitution, combining and mixing the solutions.

Reconstitution

Each vial of Ruconest (2100 U) should be reconstituted with 14 ml water for injections. Water for injections should be added slowly to avoid forceful impact on the powder and mixed gently to minimise foaming of the solution. The reconstituted solution in each vial contains 2100 U conestat alfa at 150 U/ml and appears as a clear colourless solution.

The reconstituted solution in each vial should be inspected for particulate matter and discoloration. A solution exhibiting particulates or discoloration should not be used. The medicinal product should be used immediately.

Any unused medicinal product or waste material should be disposed of in accordance with local requirements.

Package leaflet: Information for the patient

Ruconest 2100 Units powder and solvent for solution for injection conestat alfa

Read all of this leaflet carefully before you start using this medicine because it contains important information for you.

- Keep this leaflet. You may need to read it again.
- If you have any further questions, ask your doctor.
- This medicine has been prescribed for you only. Do not pass it on to others. It may harm them, even if their signs of illness are the same as yours.
- If you get any side effects, talk to your doctor. This includes any possible side effects not listed in this leaflet. See section 4.

What is in this leaflet

1. What Ruconest is and what it is used for
2. What you need to know before you use Ruconest
3. How to use Ruconest
4. Possible side effects
5. How to store Ruconest
6. Contents of the pack and other information

1. What Ruconest is and what it is used for

Ruconest contains conestat alfa as the active substance. Conestat alfa is a recombinant (not blood-derived) form of human C1 inhibitor (rhC1-INH).

Ruconest is to be used by adults, adolescents, and children (aged 2 years and above) with a rare inherited blood disorder, called Hereditary Angioedema (HAE). These patients have a shortage of the C1 inhibitor protein in their blood. This can lead to repeated attacks of swelling, pain in the abdomen, difficulty breathing and other symptoms.

The administration of Ruconest is to resolve the shortage of C1 inhibitor and will lead to reduction of symptoms of an acute attack of HAE.

2. What you need to know before you use Ruconest

Do not use Ruconest

- If you are or think you are allergic to rabbits.
- If you are allergic to conestat alfa or any of the other ingredients of this medicine (listed in section 6).

Warnings and precautions

Talk to your doctor before using Ruconest.

If you experience allergic reactions e.g. hives, rash, itching, dizziness, wheezing, difficulty breathing or your tongue swells up following the administration of Ruconest, you should seek emergency medical assistance so that symptoms of your allergic reaction can be treated urgently.

Before you start treatment with Ruconest, it is important that you tell your doctor if you have, or have had, problems with your blood clotting (thrombotic events). You will be carefully monitored if this is the case.

Hypersensitivity reactions cannot be excluded and may have symptoms similar to angioedema attacks.

Children and adolescents

Do not give this medicine to children under 2 years old. Ruconest has not been studied in children younger than 5 years of age. Your doctor will determine whether treatment of your child with Ruconest is appropriate. Additional monitoring of your child for symptoms of allergic reactions during and after administration is needed.

Other medicines and Ruconest

Tell your doctor if you are taking, have recently taken or might take any other medicines.

If you are receiving tissue type plasminogen activator as acute treatment for blood clots, you should not be treated with Ruconest at the same time.

Pregnancy and breast-feeding

It is not recommended to use Ruconest during pregnancy or breast-feeding.

If you plan becoming pregnant, discuss with your doctor before starting to use Ruconest.

Driving and using machines

Do not drive or use machinery if you feel dizzy or suffer from headache after using Ruconest.

Ruconest contains sodium (19.5 mg per vial)

This should be taken into consideration by patients on a controlled sodium diet.

3. How to use Ruconest

Ruconest will be initiated by a doctor who is specialised in the diagnosis and treatment of hereditary angioedema.

Ruconest must be administered by a healthcare professional until you or your caregiver are properly trained and capable to administer Ruconest.

Always use this medicine exactly as described in this leaflet or as your doctor or nurse have told you. Check with your doctor or nurse if you are not sure.

Ruconest is administered into a vein over about 5 minutes. Your dose will be worked out based on your body weight.

Most of the time a single dose is sufficient. An additional dose could be administered if your symptoms do not improve after 120 minutes (for adults and adolescents) or 60 minutes (for children). No more than 2 doses, calculated according to step 7, should be given within 24 hours.

You or your caregiver may inject Ruconest only after receiving adequate instructions and training from your doctor or nurse.

Instructions for use

Do not mix or administer Ruconest with other medicines or solutions. The following describes how Ruconest solution must be prepared and administered.

Before you begin

- Ensure the kit package is complete and contains all components listed in section 6 of this leaflet.
- In addition to the kit, the following is required:
 - a tourniquet
 - plaster for securing the needle
- Inspect vials and other components.
 - All vials must be sealed with plastic lid and aluminium cap and without visible damage, such as cracks in glass.
 - Check the expiry date. Never use any kit component after the expiry date stated on the big outer carton.

Within a single kit box, different components may have different expiry dates. The expiry date on

the outer carton reflects the date of the component with the shortest shelf-life.

- Allow the number of powder and solvent vials required according to step 1, to reach room temperature.

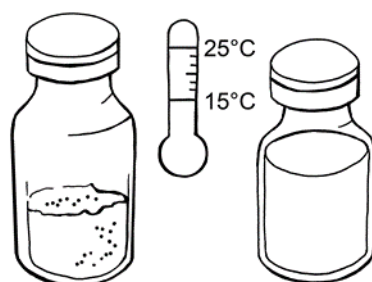

Preparation of solution

Step 1: Cleaning and other requirements

- Wash your hands carefully.
- Put the powder and solvent vials required on a flat and clean surface.
 - body weight 42 kg or less: 1 powder and 1 solvent vial
 - body weight over 42 kg: 2 powder and 2 solvent vials
- Put the vial adapters on the work surface. Do not remove the adapter packaging.
 - 2 adapters if 1 powder and 1 solvent vial is required
 - 4 adapters if 2 powder and 2 solvent vials are required
- Put the syringe(s) on the work surface. Do not remove the syringe packaging.
 - 1 syringe if 1 powder and 1 solvent vial is required
 - 2 syringes if 2 powder and 2 solvent vials are required

Step 2: Disinfection of vial stoppers

- Remove the plastic flip-off cap from the powder and solvent vials.
- Use one alcohol pad to disinfect all vial stoppers and wait for at least 30 seconds until the stoppers have dried.



- After disinfection, do not touch the stoppers with your fingers or anything else.

Step 3: Mounting of adapters on vials

- Take a packaged adapter in one hand and remove the lid. The adapter must remain in its plastic packaging.
- Put the adapter onto a powder vial, piercing the stopper, until it snaps onto the vial neck.

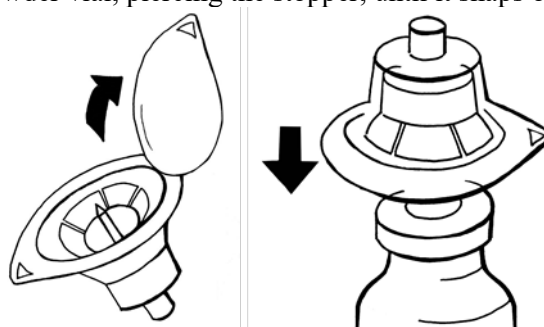

- Leave the packaging on the adapter until you attach the syringe in steps 4 and 5.
- Repeat the above steps for mounting an adapter on the solvent vial. All adapters supplied with the kit are identical.
- If you need to use a second powder and solvent vial, repeat the above steps.

Step 4: Drawing up solvent

- Take a sterile syringe out of its packaging.
- Remove the packaging from the adapter on the solvent vial.

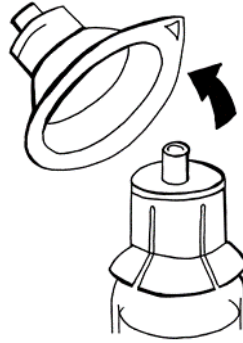

- Hold the adapter with one hand. With the other hand, attach the syringe and secure by turning it clockwise until it stops.



- Turn the whole – solvent vial with adapter and syringe – upside down. While keeping it vertical, slowly draw in 14 ml solvent. If air bubbles appear, minimise as far as possible by gently tapping the syringe and applying gentle pressure by pushing the plunger into the syringe. Continue to fill the syringe with 14 ml solvent.

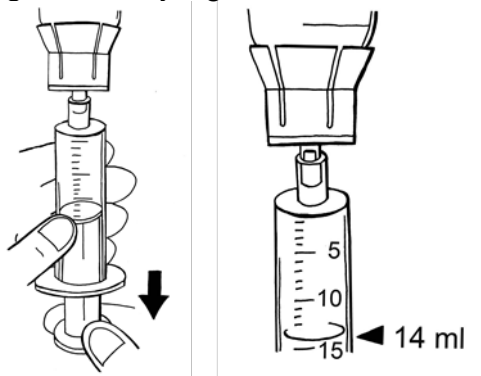

- Unlock the syringe from the adapter by turning counter-clockwise.



- Leave the remainder of the solvent in the vial and discard the vial.
- Place the syringe on the work surface, taking care not to touch the surface or any other object with the syringe tip.

Step 5: Adding solvent to powder and dissolving

- Remove the packaging from the adapter on the powder vial.
- Take the syringe with solvent that you prepared in step 4.
- Hold the adapter with the other hand and attach the syringe. Secure the syringe by turning it clockwise until it stops.
- Push the solvent slowly, in a single motion, into the powder vial in order to minimise foaming.

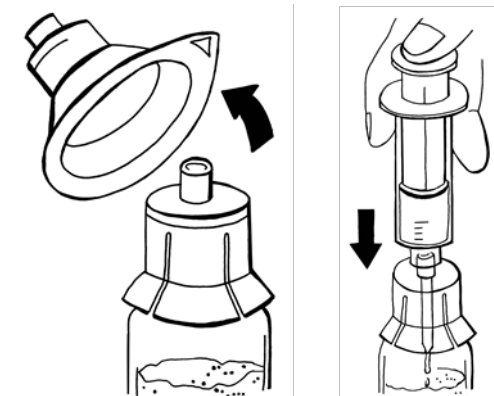

- Leave the syringe on the adapter and gently swirl the vial for approximately half a minute. Do not shake.
After swirling, leave the vial on the surface for several minutes until the solution has become clear. If undissolved powder is still present, repeat the procedure.

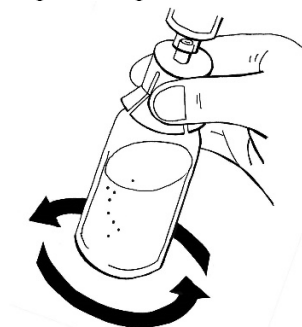

- Repeat steps 4 and 5 if you need to prepare a second solution.

Step 6: Check prepared solutions

- Check whether the powder in the vial(s) has dissolved completely and the plunger is completely pushed down in the syringe.
- After the powder has dissolved, the solution should be clear and colourless.
- Do not use the prepared solution if it is cloudy, contains particles or has changed colour. Inform your

healthcare professional if this occurs. Small amounts of foam are acceptable.

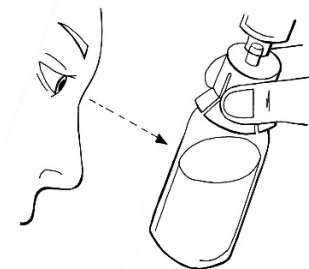

Step 7: Drawing up prepared solution

- Calculate the millilitres of prepared solution to be injected.

Body weight	Millilitres of prepared solution to be injected
below 84 kg	Body weight in kg divided by three
84 kg and above	28 ml

- Draw in the volume of prepared solution, while keeping the syringe in the vertical position. If you have prepared:
 - one vial with solution, draw up the volume as calculated
 - two vials and your body weight is below 84 kg, draw up in a similar way:
 - a) 14 ml from the first vial
 - b) from the second vial, the difference between your calculated volume and the 14 ml from the first vial
 - two vials and your body weight is 84 kg or more, draw up 14 ml from each vial into each syringe
- If air bubbles appear, minimise as far as possible by gently tapping the syringe and applying gentle pressure by pushing the plunger into the syringe. Continue to fill the syringe with the volume required.

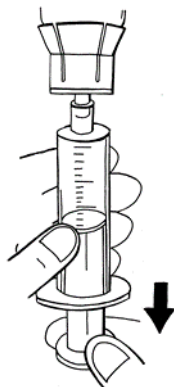

- Never exceed the volume of 14 ml per syringe.
- Unlock the syringe(s) by turning it counter-clockwise and discard the vial(s) with adapter.
- Place the syringe(s) on the work surface, taking care not to touch the surface or any other object with the syringe tip.

Step 8: Check prepared syringes

- Recheck that the volume in the syringe(s) you prepared in step 7 is correct.

Administration into a vein

It is very important that the prepared solution is injected directly into a vein and not into an artery or the surrounding tissue.

Inject the Ruconest solution immediately after preparation, preferably while seated.

Step 9: Required components

- Check that all required components are on the work surface:
 - 1 or 2 syringes with prepared solution
 - 1 infusion set with 25G needle

- 1 alcohol pad
- 1 sterile non-woven pad
- 1 self-adhesive plaster
- 1 tourniquet
- 1 plaster for securing the needle

Step 10: Preparation of the infusion set

- Remove the screw cap from the end of the infusion set. This is the end which has no needle.
- Hold this end with one hand, attach the syringe tip end and secure by turning clockwise until it stops.
- Hold the syringe with the tip pointing upwards. Gently press the syringe plunger to carefully fill the infusion set with the prepared solution.

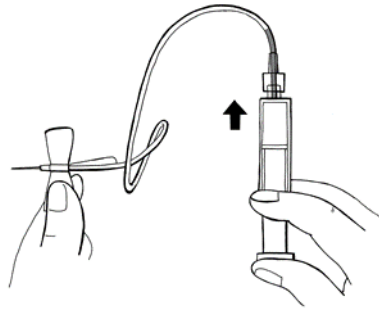

- Check that no air is present in the syringe, infusion tube or the needle.

Step 11: Preparing the injection site

- Position the tourniquet above the injection site – preferably the middle part of the upper arm. Tighten it to compress the vein. This should be boosted by tightening your fist.
- Feel, with your other hand, for an appropriate vein.
- Disinfect the injection site thoroughly with an alcohol pad and let the skin dry.

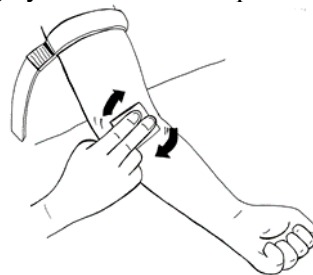

Step 12: Administration of the prepared solution

- Remove the needle cap.
- Carefully insert the needle of the infusion set, at the flattest possible angle, into the vein.

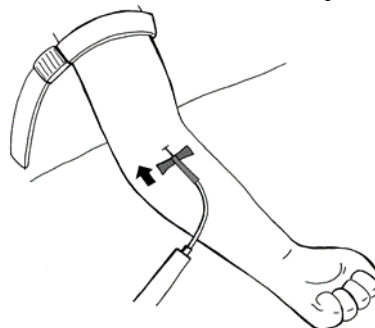

- Secure the needle by applying the plaster, around 7 cm long, over the wings of the needle.
- Carefully pull back the syringe plunger slightly until you see blood being drawn into the tubing, to ensure that the needle is in the vein.
- Release the tourniquet.
- If there is no blood in the tubing, remove the needle, repeat all steps from beginning of step 11 and

reposition the needle.

- If blood is present, gently inject the solution into the vein, as shown in the picture. Inject over about 5 minutes.

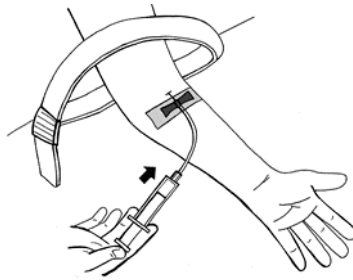

- If you have prepared two syringes:
 - fold over the tubing near the connector of the infusion set to prevent backflow
 - unscrew the empty syringe from the infusion set and immediately replace it with the second syringe

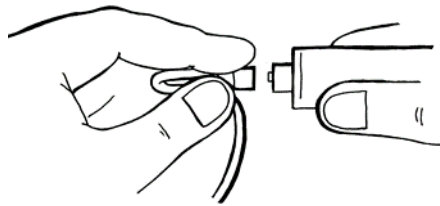

- unfold the tubing and gently inject this solution, similar to the first syringe

Step 13: After administration

- Carefully remove the plaster for securing the needle and withdraw the needle from the vein.
- Immediately after removing the needle, press the sterile pad on the injection site for a few minutes to reduce bleeding.

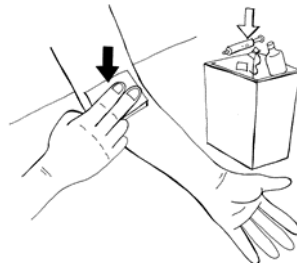

- Next, put the self-adhesive plaster on the injection site.
- Fold down the yellow protection cap over the needle.
- Safely dispose of the used infusion set with needle, any unused solution, the syringe and the empty vial in an appropriate medical waste container as these materials may hurt others if not disposed of properly. Do not reuse equipment.

Step 14: Documenting the administration

Please record (e.g. in your diary):

- date and time of the administration
- the batch number written on the label of the powder vial

If you use more Ruconest than you should

Contact your doctor or nearest hospital if this occurs.

If you have any further questions on the use of this medicine, ask your doctor.

4. Possible side effects

Like all medicines, this medicine can cause side effects, although not everybody gets them.

If your symptoms get worse and/or you develop a rash, tingling, difficulty breathing or your face or tongue swells up, get medical attention **immediately**. **This may indicate that you have developed an allergy to Ruconest.**

Some side effects may occur during treatment with Ruconest:

Common: may affect up to 1 in 10 people

- Nausea

Uncommon: may affect up to 1 in 100 people

- Abdominal pain, diarrhoea
- Sensation of tingling, prickling or numbness in the mouth
- Headache, dizziness
- Reduced sense of touch or sensation in skin or limbs
- Throat irritation
- Hives
- Swelling of the ears or the area around the ears
- Allergic shock

Not known: the frequency is not known

- Hypersensitivity reactions

Reporting of side effects

If you get any side effects, talk to your doctor. This includes any possible side effects not listed in the leaflet. You can also report side effects directly via [the national reporting system listed in Appendix V](#). By reporting side effects you can help provide more information on the safety of this medicine.

5. How to store Ruconest

Keep this medicine out of the sight and reach of children.

Do not use this medicine after the expiry date which is stated on the carton and on the label of the vial after EXP. The expiry date refers to the last day of that month.

Do not store above 25°C.

Keep the powder vial in the vial carton in order to protect from light.

Before Ruconest can be administered, the powder needs to be dissolved in the solvent included in the package (see section 3).

Once reconstituted, the product should be used immediately.

Do not use this medicine if, after dissolving, you notice particles in the solution or if the solution is discoloured. Small amounts of foam are acceptable.

6. Contents of the pack and other information

What Ruconest contains

Powder vial:

- The active substance is conestat alfa. Each powder vial contains 2100 units of conestat alfa, corresponding to 2100 units per 14 ml after reconstitution, or a concentration of 150 units/ml.
- The other ingredients of the powder are sucrose, sodium citrate (E331) and citric acid.

Solvent vial:

- The ingredient of the solvent is water for injections.

What Ruconest looks like and contents of the pack

Ruconest is presented as a single glass vial containing a white to off-white powder for solution for injection together with one glass vial containing a clear, colourless solvent to dissolve the powder. After dissolving the powder in water for injections, the solution is clear and colourless.

Ruconest is supplied with an administration kit in a carton box containing:

- 1 vial of 2100 U powder
- 1 vial of 20 ml solvent
- 2 vial adapters
- 1 syringe
- 1 infusion set with 35 cm tubing and 25G needle
- 2 alcohol pads
- 1 sterile non-woven pad
- 1 self-adhesive plaster

Marketing Authorisation Holder and Manufacturer

Marketing Authorisation Holder:

Pharming Group N.V.
Darwinweg 24
2333 CR Leiden
The Netherlands

Manufacturer:

Pharming Technologies B.V.
Darwinweg 24
2333 CR Leiden
The Netherlands

This leaflet was last revised in

Detailed information on this medicine is available on the European Medicines Agency web site:

<http://www.ema.europa.eu>.

The following information is intended for healthcare professionals only:

POSODOLOGY AND METHOD OF ADMINISTRATION

Posology

Body weight up to 84 kg

- One intravenous injection of 50 U/kg body weight.

Body weight of 84 kg or greater

- One intravenous injection of 4200 U (two vials).

In the majority of cases a single dose of Ruconest is sufficient to treat an acute angioedema attack.

In case of an insufficient clinical response, an additional dose (50 U/kg body weight up to 4200 U) can be administered.

Not more than two doses should be administered within 24 hours.

Dose calculation

Determine the patient's body weight.

Body weight up to 84 kg

- For patients up to 84 kg calculate the volume required to be administered according to the formula below:

$$\text{Volume to be administered (ml)} = \frac{\text{body weight (kg) times 50 (U/kg)}}{150 \text{ (U/ml)}} = \frac{\text{body weight (kg)}}{3}$$

Body weight of 84 kg or greater

- For patients of 84 kg or above the volume required to be administered is 28 ml, corresponding to 4200 U (2 vials).

Reconstitute *each vial* with 14 ml water for injections (see section on Reconstitution below).

The reconstituted solution in each vial contains 2100 U conestat alfa at 150 U/ml.

The required volume of the reconstituted solution should be administered as a slow intravenous injection over approximately 5 minutes.

SPECIAL PRECAUTIONS FOR DISPOSAL AND OTHER HANDLING

Preparation and handling

Each vial of Ruconest is for single use only.

Ruconest is intended for intravenous administration after reconstitution with water for injections. An aseptic technique should be used for reconstitution, combining and mixing the solutions.

Reconstitution

1. Each vial of Ruconest (2100 U) should be reconstituted with 14 ml water for injections.
2. Disinfect the rubber stoppers of the powder and solvent vials and put a vial adapter onto each solvent and powder vial until it snaps onto the vial neck.
3. Attach a syringe to the adapter on a solvent vial and turn clockwise until it locks. Draw in 14 ml of solvent. Unlock the syringe from the adapter by turning counter clockwise. Repeat this step if two powder vials need to be reconstituted.
4. Attach a syringe with solvent to the adapter on a powder vial and turn clockwise until it locks. Water for injections should be added slowly to avoid forceful impact on the powder and mixed gently to minimise foaming of the solution. Leave the syringe on the adapter. Repeat this step if a second powder vial needs to be reconstituted.
5. The reconstituted solution in each vial contains 150 U/ml and appears as a clear colourless solution. The reconstituted solution in each vial should be inspected for particulate matter and discoloration. A solution exhibiting particulates or discoloration should not be used. Small amounts of foam are acceptable. The medicinal product should be used immediately.

Administration

1. Draw in the required volume of prepared solution. Never exceed 14 ml per syringe. Unlock the syringe(s) by turning counter clockwise and discard vial(s) with adapter
2. Attach the infusion set to the syringe and turn clockwise until it locks. Hold the syringe with the tip pointing upwards and gently press the plunger to fill the infusion set with the solution
3. Disinfect the injection site with an alcohol pad. Remove the needle cap from the needle of the infusion set and carefully insert the needle into the vein.
4. Ensure that the tourniquet is released. Gently inject the solution into the vein – inject over about 5 minutes.
5. If two syringes were prepared: fold over the tubing to prevent backflow, unscrew the empty syringe from the infusion set (counter clockwise) and immediately replace it with the second syringe. Gently inject the solution of the second syringe.

Disposal

Please safely dispose of the used infusion set with needle, any unused solution, the syringe and the empty vial in an appropriate medical waste container as these materials may hurt others if not disposed of properly.

Do not reuse equipment.

ANNEX IV

**SCIENTIFIC CONCLUSIONS AND GROUNDS FOR THE VARIATION TO THE TERMS OF
THE MARKETING AUTHORISATION(S)**

Scientific conclusions

Taking into account the PRAC Assessment Report on the PSUR(s) for conestat alfa, the scientific conclusions of CHMP are as follows:

In view of available data on spontaneous reports including in some cases a close temporal relationship, and in view of a plausible mechanism of action, the PRAC considers a causal relationship between conestat alfa and

Hypersensitivity reactions

Anaphylaxis

Thromboembolic events

is at least a reasonable possibility. The PRAC concluded that the product information of products containing conestat alfa should be amended accordingly.

The CHMP agrees with the scientific conclusions made by the PRAC.

Grounds for the variation to the terms of the marketing authorisation(s)

On the basis of the scientific conclusions for conestat alfa the CHMP is of the opinion that the benefit-risk balance of the medicinal product(s) containing conestat alfa is unchanged subject to the proposed changes to the product information.

The CHMP recommends that the terms of the marketing authorisation(s) should be varied.